

BROEN-LAB

Drejervaenget 2, 5610 Assens, Denmark

Phone: +45 6376 6376

E-mail: lab@broen-lab.com

Web : broen-lab.com

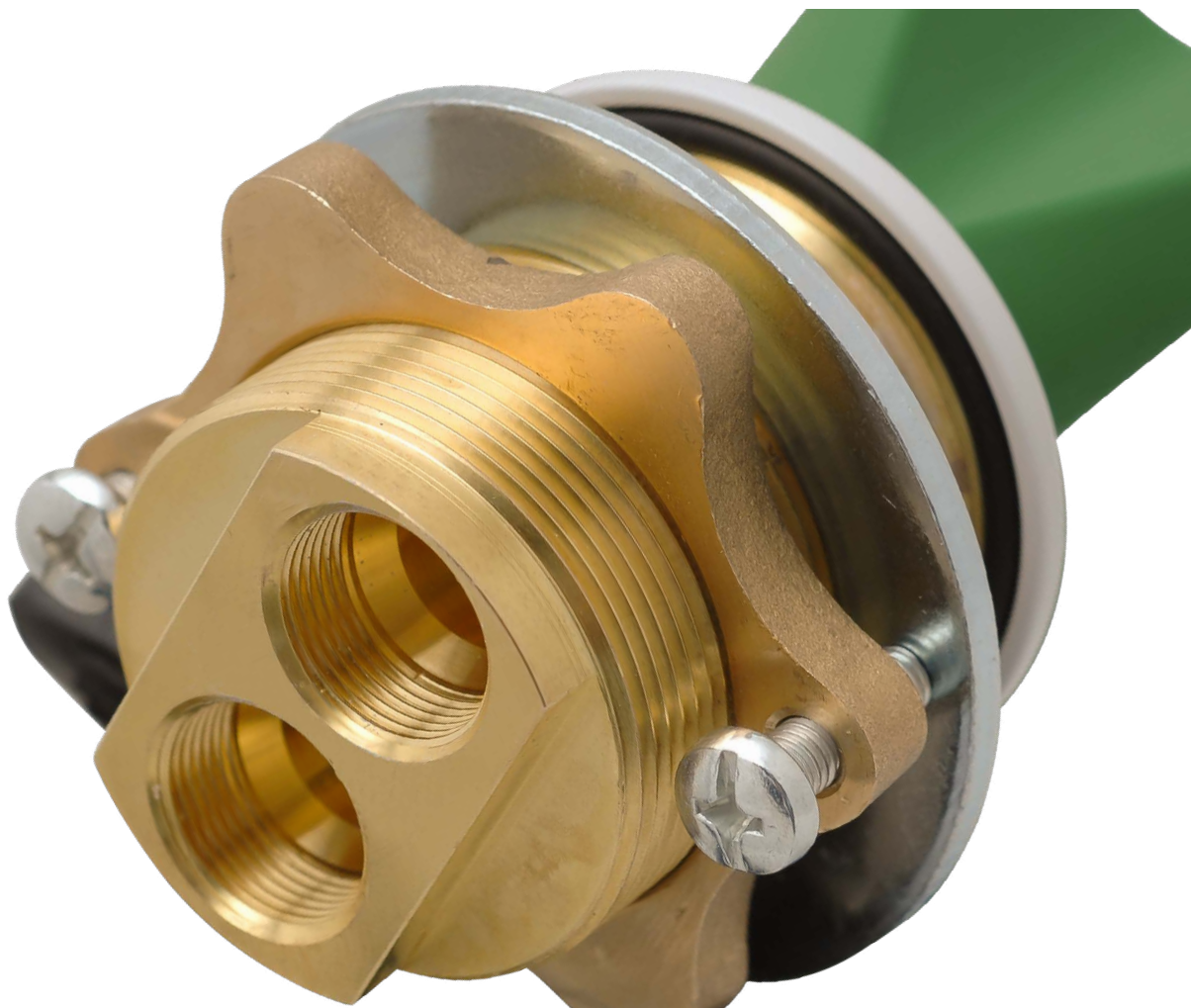

FITTINGS FOR FRONT CONTROL VALVES

PREMIUM range

99B0040 Rev. 2 - 29.01.2024

TABLE OF CONTENTS

BROEN-LAB UniFlex™			<i>Page 3</i>
Configuration overview			<i>Page 4</i>
Water	 Valve <i>Page 5</i>	 Valve <i>Page 6</i>	 Outlet <i>Page 7</i>
Special water	 Valve <i>Page 10</i>		 Outlet <i>Page 11</i>
Coolant water	 Valve <i>Page 13</i>		 Outlet <i>Page 14</i>
Burning gas	 Valve <i>Page 15</i>		 Outlet <i>Page 16</i>
Technical 2.0 gases / vacuum / high flow	 Valve <i>Page 17</i>	 Valve <i>Page 18</i>	 Outlet <i>Page 19</i>
Technical 4.0 gases / Oxygen	 Valve <i>Page 20</i>		 Outlet <i>Page 21</i>
Pure 5.0 gases	 Valve <i>Page 22</i>		 Outlet <i>Page 23</i>
Pure 6.0 gases	 Valve <i>Page 24</i>		 Outlet <i>Page 25</i>
Corrosive gases	 Valve <i>Page 26</i>		 Outlet <i>Page 27</i>
Accessories			<i>Page 28</i>
Mounting instructions - Front Control Valves			<i>Page 30</i>
Mounting instructions - Outlets			<i>Page 31</i>
Mounting instructions - Mounting of outlets into fume hoods with a double wall construction			<i>Page 32</i>
Pipe installation - Water, Special water (SS), Burning gases, Technical gases 2.0, 4.0 and 5.0			<i>Page 33</i>
Pipe installation - Special water (PP)			<i>Page 33</i>

BROEN-LAB UNIFLEX™ PREMIUM

THIS IS BROEN-LAB UNIFLEX™ PREMIUM

BROEN-LAB UniFlex™ line offers a very high quality and durability combined with the complete program, which adds up to low LCC (Life Cycle Costs). Our line takes the standards in the market to a higher level.

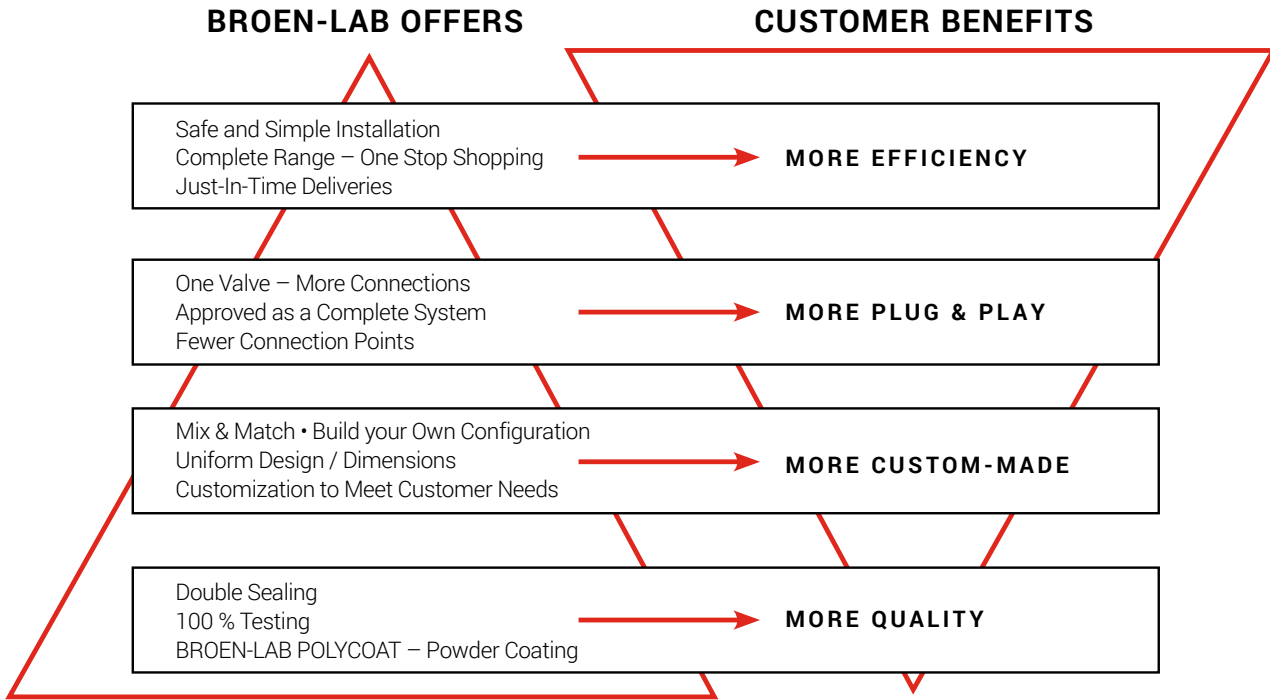

THIS IS BROEN-LAB UNIFLEX™

BROEN-LAB UniFlex™ is a unique and patented connection, which allows customers to choose from various connection methods, such as hoses, CU-, PEX or stainless steel pipes, without changing the valve itself. It provides unique flexibility, not only for the installer, but also for the end-user. Due to the flexibility of the system, the quick installation and savings on fittings, this system offers lower TIC (Total Installed Costs).

PRODUCT OVERVIEW

OUTLETS

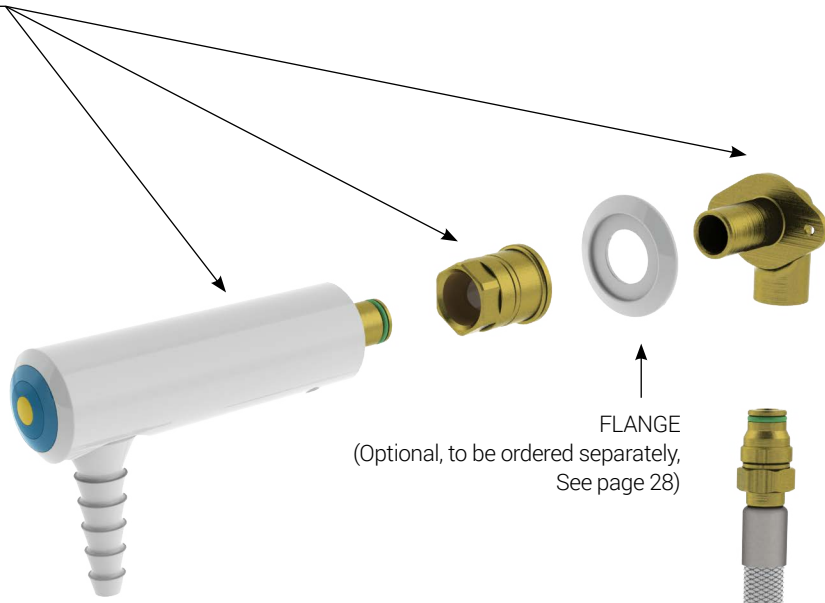

BROEN-LAB UniFlex™ flexible hoses
[See 99G0005](#)

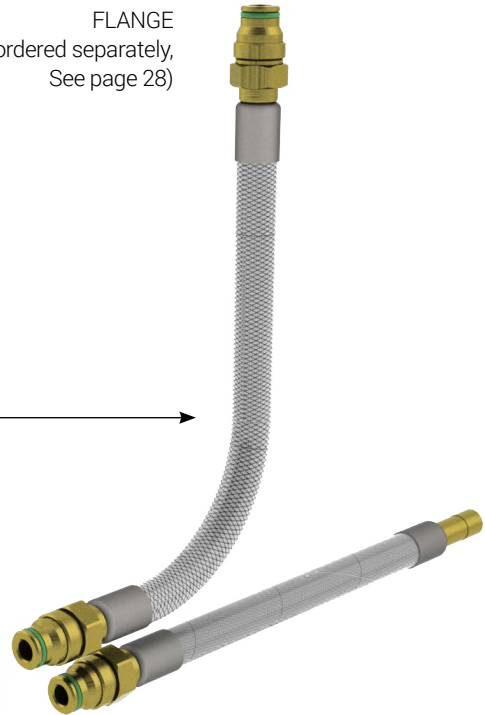
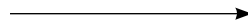

FRONT CONTROL VALVES

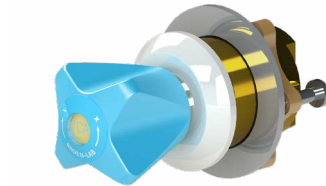

BROEN-LAB UniFlex™ connection fittings and adaptors
for CU, SS, PEX and PA pipes

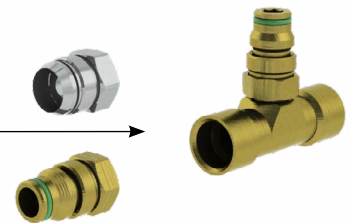

For more information about BROEN-LAB UniFlex™ flexible pipes and hoses, connection fittings and adaptors, please contact your BROEN-LAB representative or refer to www.BROEN-LAB.com

FRONT CONTROL VALVE

WATER

Specifications

Handle: Metal, BROEN-LAB POLYCOAT powder coated with media indication according to EN13792.
 Headwork: Ceramic
 Opening/closing function: 180°
 Temperature range: 0-90°C
 Max. working pressure: 10 bar / 147 psi
 Test pressure: 1 x working pressure
 Inlet/outlet: BROEN-LAB UniFlex™
 Weight: 0.7 kg

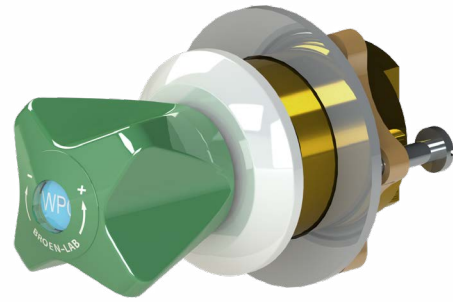

Available with or without service valve according to product numbers listed below

Materials with media contact

Metals: Brass
 Rubber: EPDM
 Plastics: POM
 Lubricant: Silicone based
 Ceramics: Al-oxyd 96%

Ordering information

For standard configuration please refer to the item numbers below.

Other options:

- a valve for different medium
- a valve for front side mounting
- a valve without mounting kit
- national approvals

For further information, please contact your BROEN-LAB representative.

Configuration options

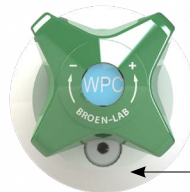

Service valve

	without service valve	with service valve
	2511 507 10XX	2511 508 10XX

Replace **XX** with one of these media types:



01 • Potable water, cold



02 • Potable water, hot



07 • Non-potable water, cold



08 • Non-potable water, hot

Delivered with mounting accessories

FRONT CONTROL VALVE WATER

Specifications

Handle: Metal, BROEN-LAB POLYCOAT powder coated with media indication according to EN13792.

Cartridge: Ceramic (with flow and temperature regulation or two step opening)

Temperature range: 0-90°C

Max.working pressure: 10 bar / 147 psi

Test pressure: 1 x working pressure

Inlet/outlet: BROEN-LAB UniFlex™

Weight: 0.6 kg

Materials with media contact

Metals: Brass

Rubber: EPDM

Plastics: POM

Lubricant: Silicone based

Ceramics: Al-oxyd 96%

Ordering information

For standard configuration please refer to the item numbers below.

Other options:

- a valve without mounting kit

For further information, please contact your BROEN-LAB representative.



Configuration options



	with flow and temperature regulation cartridge	with two step opening
	2511 529 10XX	2511 531 10XX

Replace **XX** with one of these media types:



35 • Potable water, tempered



37 • Non-potable water, tempered

Delivered with mounting accessories

OUTLET WATER

Specifications

BROEN-LAB UniFlex™ outlets have an integrated media indication according to EN 13792.
 Inlet/outlet: BROEN-LAB UniFlex™
 Max. wall thickness: 20mm
 Weight: 0.5 kg

Materials with media contact

Metals: Brass
 Rubber: EPDM
 Lubricant: Silicone based

Ordering information

For standard configuration please refer to the item numbers below.

Other options:

- other media
- flange
- non-return valve
- fixed nozzle
- other standout
- straight rear wall connection
- wall thickness 20-40mm
- double wall mounting
- table mounting
- additional support in case of a thin panel
- national approvals

For further information, please contact your BROEN-LAB representative.

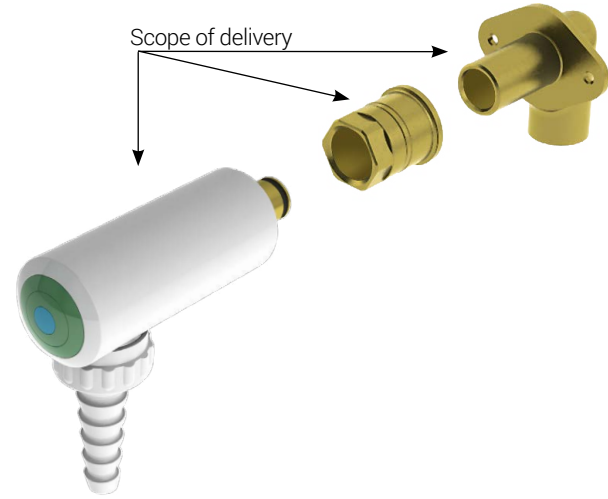

Additional mounting information see page 30-33

With removable nozzle

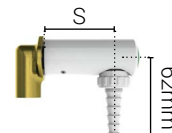
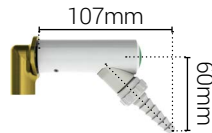

	45°	90° S = 53 mm	90° S = 75 mm	90° S = 90 mm
	2511 101 10XX-40	2511 111 10XX-40	2511 121 10XX-40	2511 131 10XX-40

With quick release coupling

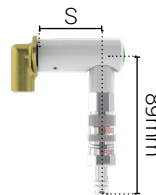
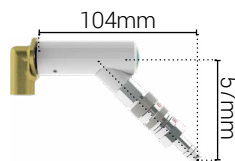

	45°	90° S = 53 mm	90° S = 75 mm	90° S = 90 mm
	2511 102 10XX-40	2511 112 10XX-40	2511 122 10XX-40	2511 132 10XX-40

Replace **XX** with one of these media types:



01 • Potable water, cold



07 • Non-potable water, cold



35 • Potable water, tempered



02 • Potable water, hot



08 • Non-potable water, hot



37 • Non-potable water, tempered

Delivered with 90° Rear Wall Connection (max wall thickness: 20mm)

OUTLET SPOUT WATER

With swivel spout



	U = 150 mm	U = 200 mm	S = 150 mm	S = 200 mm
	2511 212 10XX-40	2511 213 10XX-40	2511 214 10XX-40	2511 215 10XX-40

Bench mounted outlet with swivel spout

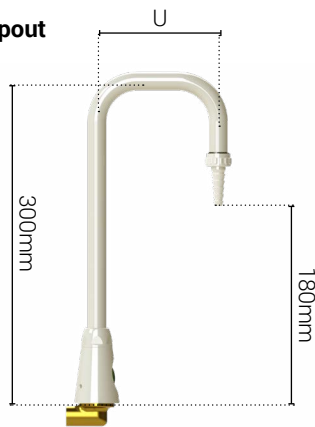

	U = 150 mm	U = 200 mm
	2511 300 10XX-40	2511 301 10XX-40

45° Outlet with fixed or swivel spout

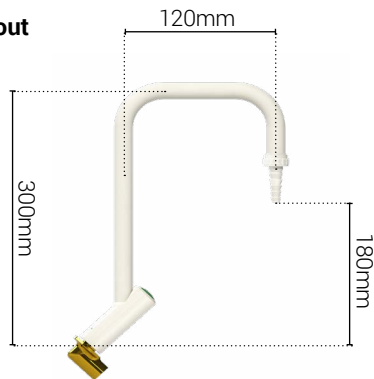

	Fixed spout	Swivel spout
	2511 307 10XX-40	2511 308 10XX-40

Replace **XX** with one of these media types:



01 • Potable water, cold



07 • Non-potable water, cold



35 • Potable water, tempered



02 • Potable water, hot



08 • Non-potable water, hot



37 • Non-potable water, tempered

Delivered with 90° Rear Wall Connection (max wall thickness: 20mm)

OUTLET SPOUT WATER

Specifications

Inlet: BROEN-LAB UniFlex™
Hose nozzle: Metal, Removable
Temperature range: 0-65°C
Weight: 0.7 kg

Materials with media contact

Metals: Brass
Rubber: EPDM
Lubricant: Silicone based

Ordering information

For standard configuration please refer to the item numbers below.

Other options:

- non-return valve
- removable nozzle
- other inlet connections (length, type)

For further information, please contact your BROEN-LAB representative.

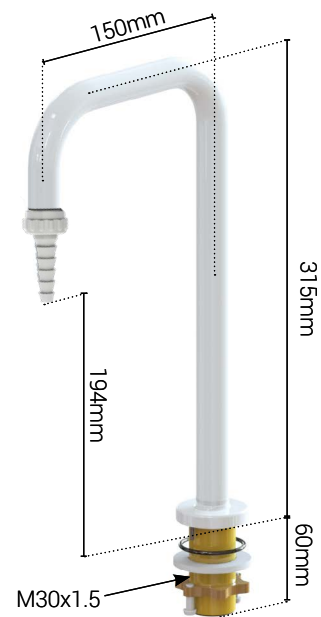

Ordering information

	2539 039 10XX-52

Replace **XX** with one of these media types:



01 • Potable water, cold



07 • Non-potable water, cold



35 • Potable water, tempered



02 • Potable water, hot



08 • Non-potable water, hot



37 • Non-potable water, tempered

Delivered with mounting accessories

FRONT CONTROL VALVE SPECIAL WATER

Specifications

Handle: Metal, BROEN-LAB POLYCOAT powder coated with media indication according to EN13792.

Headwork: Diaphragm type

Opening/closing function: 1 1/2 x 360°

Max. working pressure: 10 bar / 147 psi

Test pressure: 1 x working pressure

Weight: 0.7 kg

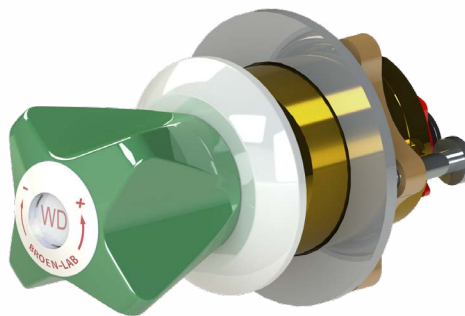

PP valve

Temperature range: 0-65°C

Inlet/outlet: Push couplings for OD10mm pipes

SS Valve

Temperature range: 0-90°C

Inlet/outlet: BROEN-LAB UniFlex™

Available in PP or Stainless Steel according to product numbers listed below

Materials with media contact

PP valve

Diaphragm: PTFE

Plastics: PP

SS Valve

Diaphragm: PTFE

Metals: SS (AISI 316)

Ordering information

For standard configuration please refer to the item numbers below.

Other options:

- a valve without mounting kit
- a valve for front side mounting

For further information, please contact your BROEN-LAB representative.

Configuration options



	PP valve	SS valve
	2511 533 10XX	2511 535 10XX

Replace **XX** with one of these media types:



03 • Distilled water



36 • Deionized water, cold

Delivered with mounting accessories

OUTLET SPECIAL WATER

Specifications

BROEN-LAB UniFlex™ outlets have an integrated media indication according to EN 13792.
 Inlet: Push couplings for OD10mm pipes
 Max. wall thickness: 20mm
 Weight: 0.5 kg

Materials with media contact

Rubber: EPDM
 Plastics: PP

Ordering information

For standard configuration please refer to the item numbers below.

Other options:

- flange
- wall thickness 20-40mm
- swivel spout (U- or S-shape)
- additional support in case of a thin panel

For further information, please contact your BROEN-LAB representative.

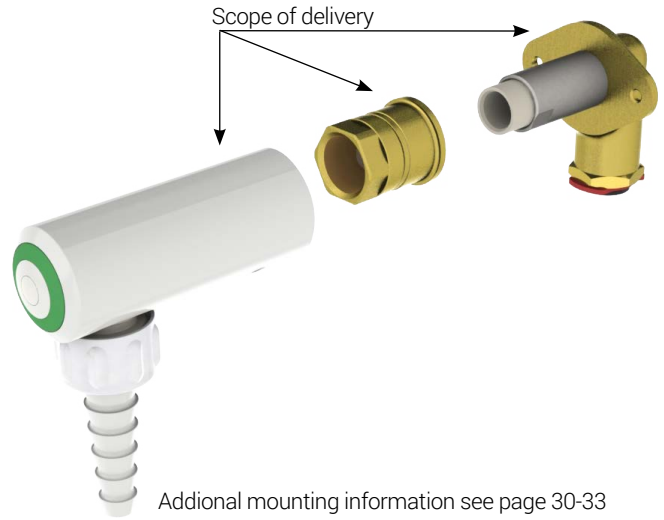

Configuration options

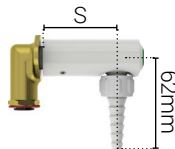

	S = 53 mm	S = 75 mm	S = 90 mm
	2511 116 10XX-40	2511 126 10XX-40	2511 136 10XX-40

Replace **XX** with one of these media types:



03 • Distilled water



36 • Deionized water, cold

Delivered with 90° Rear Wall Connection (max wall thickness: 20mm)

FRONT CONTROL VALVE SPECIAL WATER

Specifications

BROEN-LAB UniFlex™ outlets have an integrated media indication according to EN 13792.
 Inlet: BROEN-LAB UniFlex™
 Max. wall thickness: 20mm
 Weight: 0.5 kg

Materials with media contact

Rubber: EPDM
 Metals: Stainless Steel (AISI 316)

Ordering information

For standard configuration please refer to the item numbers below

Other options:

- flange
- straight rear wall connection
- fixed nozzle with external G3/4" thread
- wall thickness 20-40mm
- additional support in case of a thin panel

For further information, please contact your BROEN-LAB representative.



Configuration options

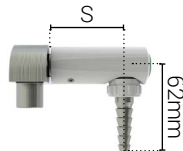

	S = 53 mm	S = 90 mm
	2511 117 10XX-40	2511 137 10XX-40

Replace **XX** with one of these media types:



03 • Distilled water



36 • Deionized water, cold

Delivered with 90° Rear Wall Connection (max wall thickness: 20mm)

FRONT CONTROL VALVE

COOLANT WATER

Specifications

Handle: Metal, BROEN-LAB POLYCOAT powder coated with media indication according to EN13792.
 Headwork: Rubber
 Opening/closing function: 2 x 360°
 Temperature range: 0-90°C
 Max. working pressure: 10 bar / 147 psi
 Test pressure: 1 x working pressure
 Inlet/outlet: BROEN-LAB UniFlex™
 Weight: 0.7 kg

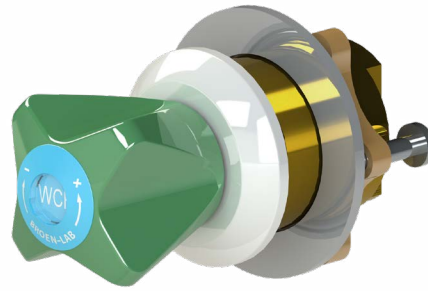

Materials with media contact

Metals: Brass
 Rubber: EPDM
 Lubricant: Silicone based

Available with or without service valve according to product numbers listed below

Ordering information

For standard configuration please refer to the item numbers below.

Other options:

- a valve for front side mounting
- a valve without mounting kit
- a valve with simple hand operation of flow and return of chilled water

For further information, please contact your BROEN-LAB representative.

Configuration options

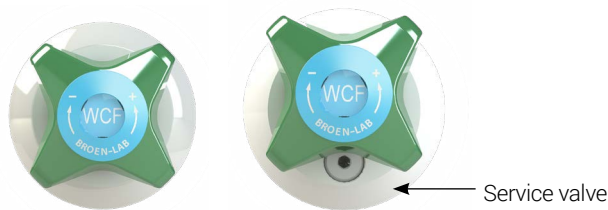

	without service valve	with service valve
	2511 503 10XX	2511 504 10XX

Replace **XX** with one of these media types:



05 • Coolant water, feed



06 • Coolant water, return

Delivered with mounting accessories

OUTLET COOLANT WATER

Specifications

BROEN-LAB UniFlex™ outlets have an integrated media indication according to EN 13792.
 Inlet/outlet: BROEN-LAB UniFlex™
 Max. wall thickness: 20mm
 Weight: 0.5 kg
 Quick release coupling: double shut-off

Materials with media contact

Metals: Brass
 Rubber: EPDM
 Lubricant: Silicone based

Ordering information

For standard configuration please refer to the item numbers below.

Other options:

- flange
- other standout
- straight rear wall connection
- wall thickness 20-40mm
- double wall mounting
- additional support in case of a thin panel

For further information, please contact your BROEN-LAB representative.

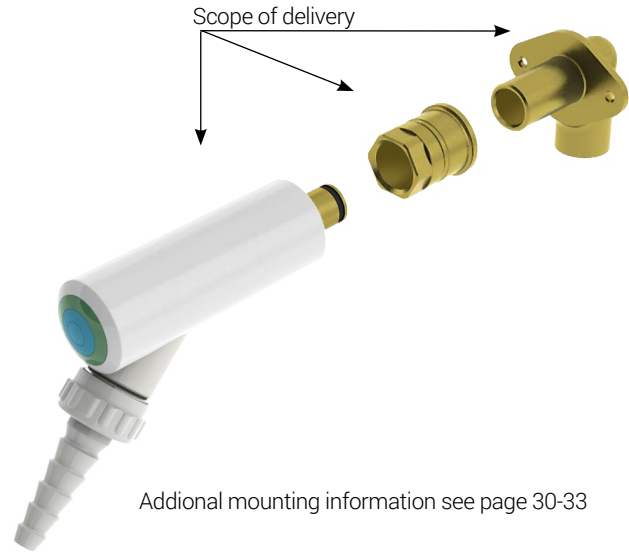

With removable nozzle and integrated non-return valve

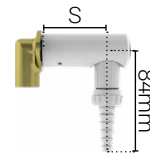
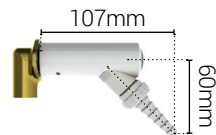

	45°	90° S = 53 mm	90° S = 75 mm	90° S = 90 mm
	2511 104 10XX-40	2511 114 10XX-40	2511 124 10XX-40	2511 134 10XX-40

With quick release coupling and non-return valve (return only)

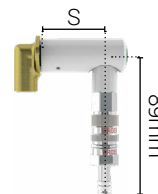
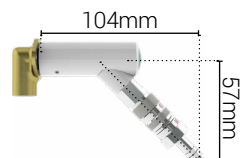

	45°	90° S = 53 mm	90° S = 75 mm	90° S = 90 mm
	2511 102 10XX-40	2511 112 10XX-40	2511 122 10XX-40	2511 132 10XX-40

Replace **XX** with one of these media types:



05 • Coolant water, feed



06 • Coolant water, return

Delivered with 90° Rear Wall Connection (max wall thickness: 20mm)

FRONT CONTROL VALVE

BURNING GAS

Specifications

Handle: Metal, BROEN-LAB POLYCOAT powder coated with media indication according to EN13792.
 Headwork: ceramic, press/turn
 Opening/closing function: 90°
 Max.working pressure: 7 bar / 101,5 psi
 Test pressure: 1.5 x working pressure
 Inlet/outlet: BROEN-LAB UniFlex™
 Weight: 0.7 kg

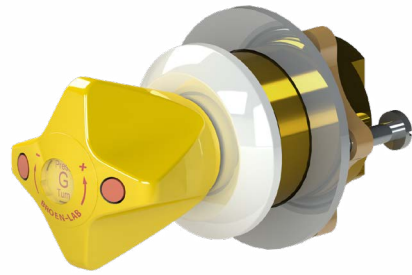

Materials with media contact

Metals: Brass
 Rubber: NBR
 Lubricant: Mineral oil based

Available with or without service valve according to product numbers listed below

Ordering information

For standard configuration please refer to the item numbers below.

Other options:

- a valve for different medium
- a valve for front side mounting
- a valve without mounting kit

For further information, please contact your BROEN-LAB representative.

Configuration options



Service valve

	without service valve	with service valve
	2511 519 10XX	2511 520 10XX

Replace **XX** with one of these media types:



10 • Natural Gas



12 • Liquefied Gases



14 • Butane



16 • Propane



18 • Acetylene



20 • Hydrogen



46 • Methane

Delivered with mounting accessories

OUTLET BURNING GAS

Specifications

BROEN-LAB UniFlex™ outlets have an integrated media indication according to EN 13792.
 Inlet/outlet: BROEN-LAB UniFlex™
 Max. wall thickness: 20mm
 Weight: 0.5 kg

Materials with media contact

Metals: Brass
 Rubber: NBR
 Lubricant: Mineral oil based

Ordering information

For standard configuration please refer to the item numbers below.

Other options:

- other media
- flange
- other standout
- straight rear wall connection
- wall thickness 20-40mm
- double wall mounting
- table mounting
- additional support in case of a thin panel

For further information, please contact your BROEN-LAB representative.

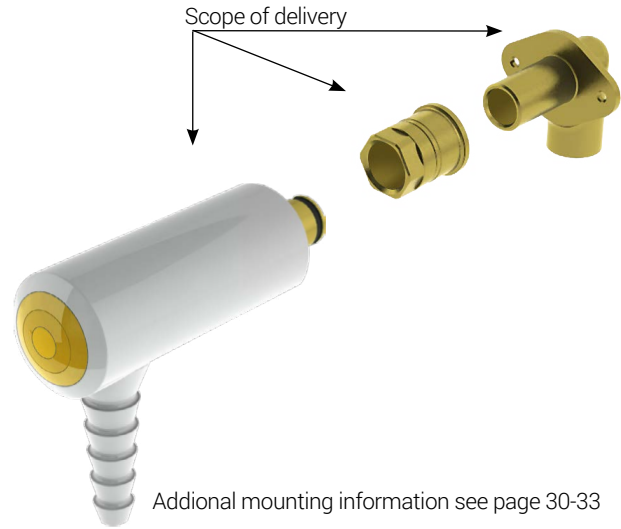

With fixed nozzle

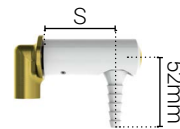
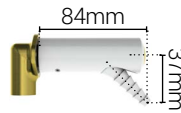

	45°	90° S = 53 mm	90° S = 75 mm	90° S = 90 mm
	2511 100 10 XX -40	2511 110 10 XX -40	2511 120 10 XX -40	2511 130 10 XX -40

With quick release coupling

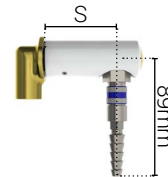
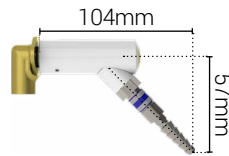

	45°	90° S = 53 mm	90° S = 75 mm	90° S = 90 mm
	2511 102 10 XX -40	2511 112 10 XX -40	2511 122 10 XX -40	2511 132 10 XX -40

Replace **XX** with one of these media types:

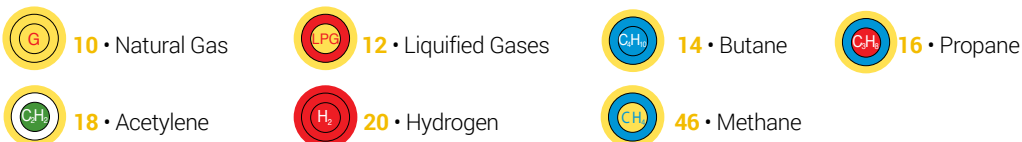

Delivered with 90° Rear Wall Connection (max wall thickness: 20mm)

FRONT CONTROL VALVE

TECHNICAL GASES 2.0 & VACUUM/HIGH FLOW

Specifications

Handle: Metal, BROEN-LAB POLYCOAT powder coated with media indication according to EN13792.
 Inlet/outlet: BROEN-LAB UniFlex™
 Weight: 0.7 kg
 Test pressure: 1.5 x working pressure

Technical 2.0 gases

Headwork: Needle
 Opening/closing function: 3 x 360°
 Max. working pressure: 16 bar / 232 psi

Headwork: Micro flow
 Opening/closing function: 7.5 x 360°
 Max. working pressure: 16 bar / 232 psi

Vacuum / High Flow*

Headwork: High flow
 Opening/closing function: 1.5 x 360°
 Max. working pressure: -1 bar to 16 bar / -14.5 psi to 232 psi

Materials with media contact

Metals: Brass
 Rubber: FKM
 Plastics: PVDF
 Lubricant: Perfluoropolyether based

Ordering information

For standard configuration please refer to the item numbers below.

Other options:

- a valve for front side mounting
- a valve without mounting kit

For further information, please contact your BROEN-LAB representative.

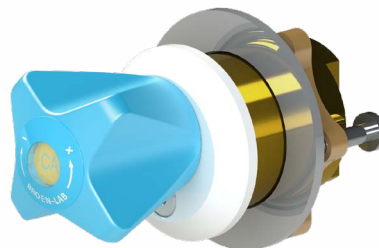

Available with or without service valve according to product numbers listed below

*Please note that valves for vacuum as a standard delivered with a high flow headwork. High flow headwork can also be used for other media where there is a requirement for higher flow.

Configuration options

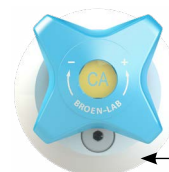

Service valve

	Without service valve Needle headwork	Without service valve Micro flow headwork	With service valve Needle headwork	With service valve Micro flow headwork
	2511 511 10XX	2511 546 10XX	2511 512 10XX	2511 547 10XX

Replace **XX** with one of these media types:



21 • Compressed air



23 • Nitrogen



24 • Carbon dioxide



25 • Argon



26 • Helium

	Without service valve High flow headwork	With service valve High flow headwork
	2511 515 1028	2511 516 1028



28 • Low vacuum (1000 to 1 mbar)

Delivered with mounting accessories

FRONT CONTROL VALVE PRESSURE REGULATOR

Specifications

BROEN-LAB UniFlex™ pressure regulator for panel mounting with a built-in filter (mesh size 200 µm) on the inlet.

Type: Non-relieving

Proof pressure: 15 bar

Operating pressure: Max. 10 bar

Regulating pressure range: 0,5-8.5 bar

Inlet/outlet: BROEN-LAB UniFlex™

Max. panel thickness: 3,5mm

Weight: 0.5 kg

Materials with media contact

Metals: Brass, zinc die-cast

Rubber: NBR, FKM

Plastics: POM

Lubricant: Perfluoropolyether based

Ordering information

For standard configuration please refer to the item numbers below.

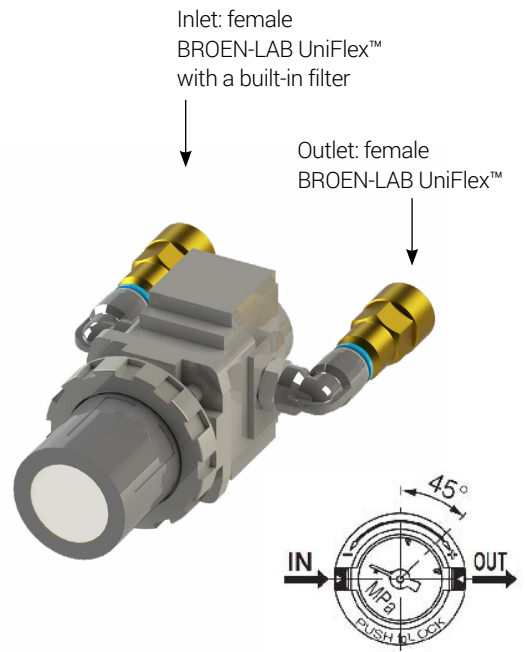

Flow rate

Input pressure $p_1 = 7$ bar

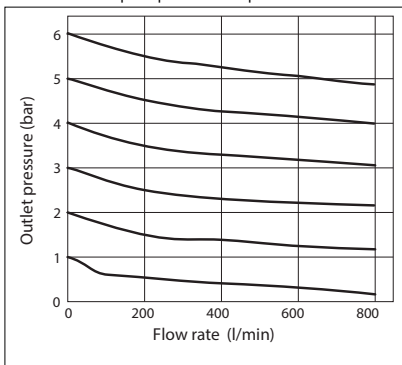

Pressure characteristics

Input pressure $p_1 = 7$ bar

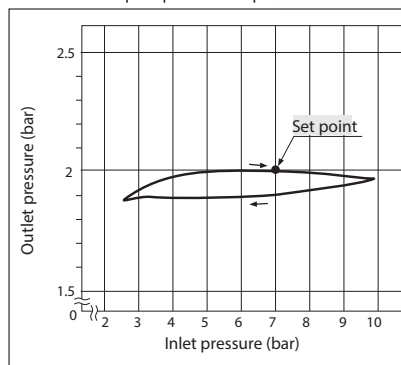

Ordering information

	2599 366 1099



21 • Compressed air



23 • Nitrogen



24 • Carbon dioxide



25 • Argon

Media should be defined when ordering.

Can be used for CA, N2, CO2, Ar. Not recommended for Helium (He). Do not use for Oxygen (O2)!

OUTLET

TECHNICAL GASES 2.0 & VACUUM/HIGH FLOW

Specifications

BROEN-LAB UniFlex™ outlets have an integrated media indication according to EN 13792.
 Inlet/outlet: BROEN-LAB UniFlex™
 Max. wall thickness: 20mm
 Weight: 0.5 kg

Materials with media contact

Metals: Brass
 Rubber: FKM
 Plastics: PVDF
 Lubricant: Perfluoropolyether based

Ordering information

For standard configuration please refer to the item numbers below.

Other options:

- other media
- flange
- straight rear wall connection
- wall thickness 20-40mm
- double wall mounting
- table mounting
- additional support in case of a thin panel

For further information, please contact your BROEN-LAB representative.

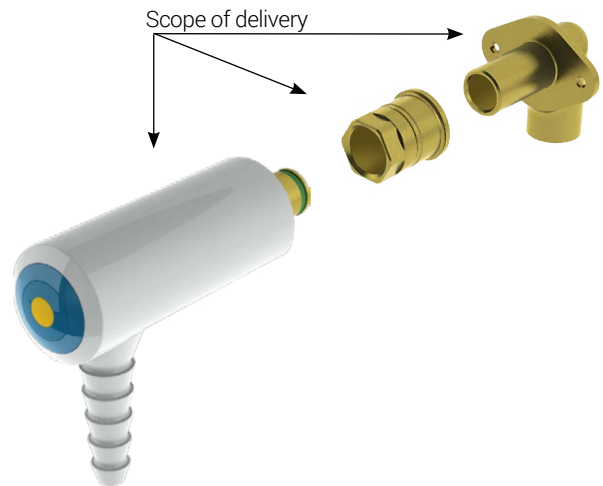

Additional mounting information see page 30-33

With fixed nozzle

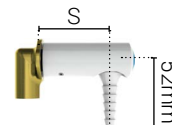
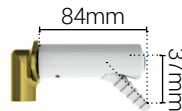

	45°	90° S = 53 mm	90° S = 75 mm	90° S = 90 mm
2.0 gases	2511 100 10XX-40	2511 110 10XX-40	2511 120 10XX-40	2511 130 10XX-40
Vacuum	2511 100 1028-40	2511 110 1028-40	2511 120 1028-40	2511 130 1028-40

With quick release coupling

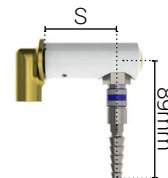
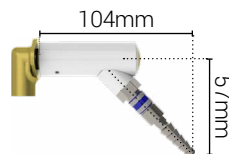

	45°	90° S = 53 mm	90° S = 75 mm	90° S = 90 mm
2.0 gases	2511 102 10XX-40	2511 112 10XX-40	2511 122 10XX-40	2511 132 10XX-40
Vacuum	2511 102 1028-40	2511 112 1028-40	2511 122 1028-40	2511 132 1028-40

Replace **XX** with one of these media types:

- 21** • Compressed air
- 23** • Nitrogen
- 24** • Carbon dioxide
- 25** • Argon
- 26** • Helium
- 28** • Low vacuum (1000 to 1 mbar)

Delivered with 90° Rear Wall Connection (max wall thickness: 20mm)

FRONT CONTROL VALVE

TECHNICAL GASES 4.0 & OXYGEN

Specifications

Handle: Metal, BROEN-LAB POLYCOAT powder coated with media indication according to EN13792.

Inlet/outlet: BROEN-LAB UniFlex™

Weight: 0.7 kg

Test pressure: 1.5 x working pressure

Headwork: Needle

Opening/closing function: 3 x 360°

Max. working pressure: 16 bar / 232 psi

Headwork: Micro flow

Opening/closing function: 7.5 x 360°

Max. working pressure: 16 bar / 232 psi

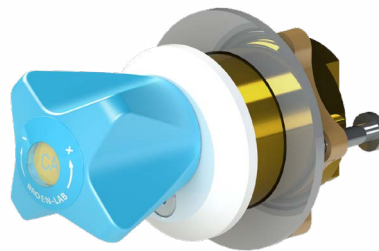

Available with or without service valve according to product numbers listed below

Materials with media contact

Metals: Brass

Rubber: FKM

Plastics: PVDF

Lubricant: Perfluoropolyether based (Oxygen approved)

All components are ultrasonically cleaned for 99,99% clean gases

Ordering information

For standard configuration please refer to the item numbers below.

Other options:

- a valve for front side mounting
- a valve without mounting kit

For further information, please contact your BROEN-LAB representative.

Configuration options

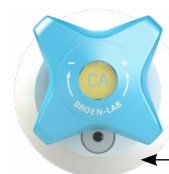

Service valve

	Without service valve Needle headwork	Without service valve Micro flow headwork	With service valve Needle headwork	With service valve Micro flow headwork
	2511 527 10 XX	2511 550 10 XX	2511 528 10 XX	2511 551 10 XX

Replace **XX** with one of these media types:



21 • Compressed air



22 • Oxygen



23 • Nitrogen



24 • Carbon dioxide



25 • Argon



26 • Helium



27 • Dinitrogen monoxide

Delivered with mounting accessories

OUTLET

TECHNICAL GASES 4.0 & OXYGEN

Specifications

BROEN-LAB UniFlex™ outlets have an integrated media indication according to EN 13792.
 Inlet/outlet: BROEN-LAB UniFlex™
 Max. wall thickness: 20mm
 Weight: 0.5 kg

Materials with media contact

Metals: Brass
 Rubber: FKM
 Plastics: PVDF
 Lubricant: Perfluoropolyether based (Oxygen approved)

All components are ultrasonically cleaned for 99,99% clean gases

Ordering information

For standard configuration please refer to the item numbers below.

Other options:

- other media
- flange
- removable nozzle
- other standout
- straight rear wall connection
- wall thickness 20-40mm
- table mounting
- additional support in case of a thin panel

For further information, please contact your BROEN-LAB representative.

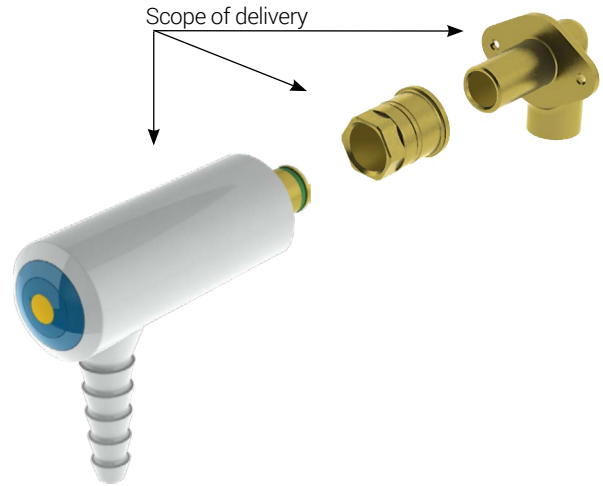

Additional mounting information see page 30-33

With fixed nozzle

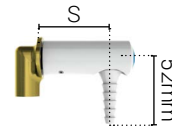
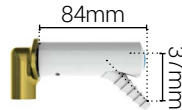

	45°	90° S = 53 mm	90° S = 75 mm	90° S = 90 mm
	2511 108 10XX-40	2511 118 10XX-40	2511 128 10XX-40	2511 138 10XX-40

With quick release coupling

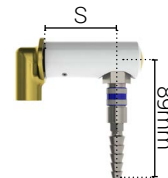
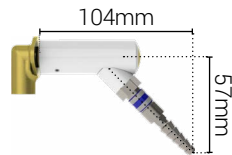

	45°	90° S = 53 mm	90° S = 75 mm	90° S = 90 mm
	2511 185 10XX-40	2511 186 10XX-40	2511 187 10XX-40	2511 190 10XX-40

Replace **XX** with one of these media types:

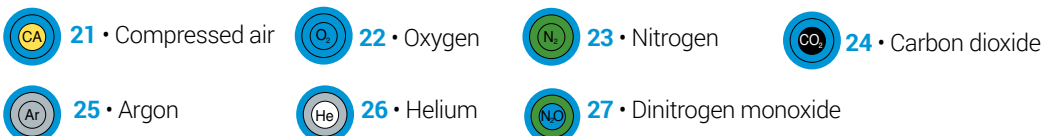

Delivered with 90° Rear Wall Connection (max wall thickness: 20mm)

FRONT CONTROL VALVE

PURE 5.0 GASES

Specifications

Valve can be used for non-corrosive and inactive gases with purity coefficient up to 5.0 (99.999% pure gases).

Handle: Metal, BROEN-LAB POLYCOAT powder coated with media indication according to EN13792.

Inlet/outlet: BROEN-LAB UniFlex™

Leak rate: < 5x10⁻⁵ mbar x l/s [Helium]

Weight: 0.7 kg

Test pressure: 1.5 x working pressure

Headwork: Needle

Opening/closing function: 3 x 360°

Max. working pressure: 21 bar / 305 psi

Headwork: Micro flow

Opening/closing function: 7.5 x 360°

Max. working pressure: 16 bar / 232 psi

Shut-off Valve

Headwork: Stop

Opening/closing function: 1.5 x 360°

Max. working pressure: 21 bar / 305 psi

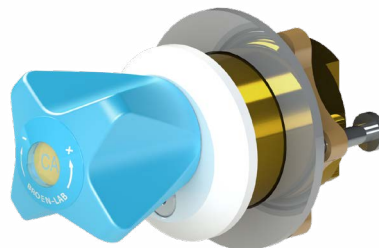

Materials with media contact

Metals: Brass

Rubber: FKM

Plastics: PVDF

Lubricant: Perfluoropolyether based (Oxygen approved)

All components are ultrasonically cleaned for 99,999% clean gases

Ordering information

For standard configuration please refer to the item numbers below.

Other options:

- a valve for front side mounting

- a valve without mounting kit

- inlet/outlet with female 1/4 NPT thread

For further information, please contact your BROEN-LAB representative.

Configuration options



	Shut-off valve	Needle valve	Micro flow valve
Fixed nozzle	2511 543 10XX	2511 542 10XX	2511 553 10XX

Replace **XX** with one of these media types:



21 • Compressed air



22 • Oxygen



23 • Nitrogen



24 • Carbon dioxide



25 • Argon



26 • Helium



27 • Dinitrogen monoxide

Delivered with mounting accessories

OUTLET

PURE 5.0 GASES

Specifications

Outlets can be used for non-corrosive and inactive gases with purity coefficient up to 5.0 (99,999% pure gases).

BROEN-LAB UniFlex™ outlets have an integrated media indication according to EN 13792.

Inlet: BROEN-LAB UniFlex™

Outlet: Female 1/4 NPT

Leak rate: $< 5 \times 10^{-5}$ mbar x l/s [Helium]

Max. wall thickness: 20mm

Weight: 0.5 kg

Materials with media contact

Metals: Brass

Rubber: FKM

Plastics: PVDF

Lubricant: Perfluoropolyether based (Oxygen approved)

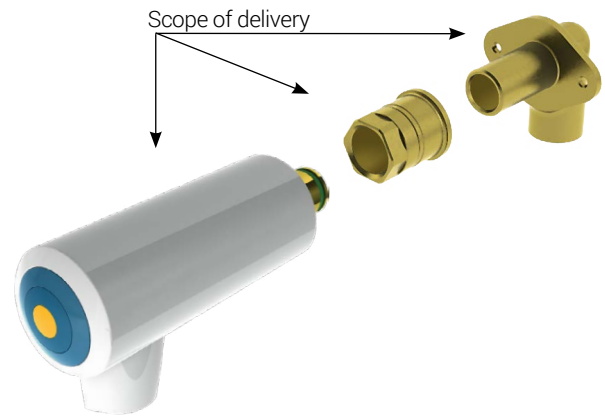

Additional mounting information see page 30-33

All components are ultrasonically cleaned for 99,999% clean gases.

Ordering information

For standard configuration please refer to the item numbers below.

Other options:

- other media
- flange
- straight rear wall connection
- wall thickness 20-40mm
- table mounting
- additional support in case of a thin panel
- Swagelok® tube fittings
- inlet with female 1/4 NPT thread

For further information, please contact your BROEN-LAB representative.

Configuration options

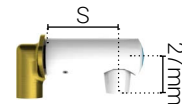
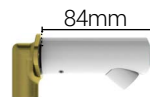

	45°	90° S = 53 mm	90° S = 75 mm	90° S = 90 mm
	2511 109 10XX-40	2511 119 10XX-40	2511 129 10XX-40	2511 139 10XX-40

Replace **XX** with one of these media types:



21 • Compressed air



22 • Oxygen



23 • Nitrogen



24 • Carbon dioxide



25 • Argon



26 • Helium



27 • Dinitrogen monoxide

Delivered with 90° Rear Wall Connection (max wall thickness: 20mm)

FRONT CONTROL VALVE

PURE 6.0 GASES

Specifications

Valve can be used for non-corrosive and inactive gases with purity coefficient up to 6.0 (99.9999% pure gases).

Handle: Metal, BROEN-LAB POLYCOAT powder coated with media indication according to EN13792.

Headwork: Diaphragm type

Opening/closing function: 1.5 x 360°

Max. working pressure: 21 bar / 305 psi

Test pressure: 1.5 x working pressure

Inlet/outlet: Female 1/4" NTP thread

Leak rate: < 10⁻⁷ mbar x l/s [Helium]

Weight: 0.7 kg

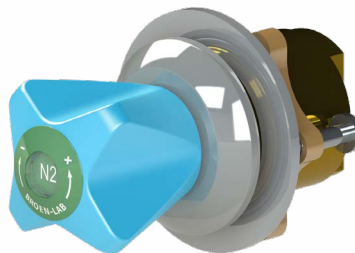

Materials with media contact

Metals: Brass

Plastics: PVDF

Diaphragm: Stainless Steel Alloy

Ordering information

For standard configuration please refer to the item numbers below.

Media should be defined when ordering.

Other options:

- Swagelok® tube fittings

For further information, please contact your BROEN-LAB representative.

Configuration options



	Stop valve	Flow valve
All media	02 460.009-9023	02 462.009-9023

Media should be defined when ordering.

Delivered with mounting accessories

OUTLET

PURE 6.0 GASES

Specifications

Outlets can be used for non-corrosive and inactive gases with purity coefficient up to 6.0 (99,9999% pure gases).

Inlet/outlet: Female 1/4 NPT thread

Leak rate: < 10⁻⁷ mbar x l/s [Helium]

Weight: 0.5 kg

Materials with media contact

Metals: Brass (Stainless Steel for bulk head union outlet)

Ordering information

For standard configuration please refer to the item numbers below.

Swagelok® tube fittings must be ordered separately.

For further information, please contact your BROEN-LAB representative.

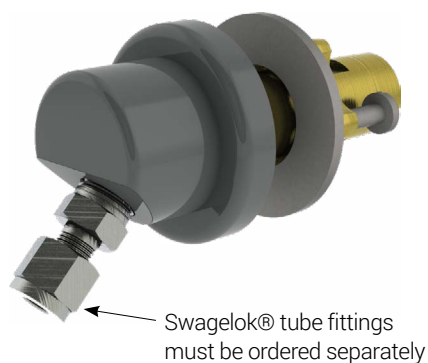

Configuration options

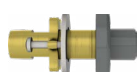
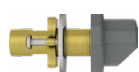

	45°	Straight	Bulk head union
All media	02 869.529-9023	02 861.529-9023	02 566.009-9023

Media should be defined when ordering.

FRONT CONTROL VALVE

CORROSIVE GAS

Specifications

Valve can be used for corrosive gases with purity coefficient up to 6.0 (99.9999% pure gases).

Handle: Metal, BROEN-LAB POLYCOAT powder coated with media indication according to EN13792.

Headwork: Diaphragm type

Opening/closing function: 1.5 x 360°

Max. working pressure: 16 bar / 232 psi

Test pressure: 1.5 x working pressure

Inlet/outlet: SS tubes for OD 8mm

Leak rate: < 10⁻⁷ mbar x l/s [Helium]

Weight: 0.7 kg



Materials with media contact

Metals: Stainless Steel (AISI 316L)

Plastics: PVDF

Ordering information

For standard configuration please refer to the item numbers below.

Media should be defined when ordering.

Other options:

- a valve without mounting kit

For further information, please contact your BROEN-LAB representative.

To connect flexible pipes to this solutions, remember to offer three Swagelok® from page 29.

See how to install the solution on page 33.

Configuration options



	Without service valve
 Corrosive gases	2511 539 1099

Media should be defined when ordering.

Delivered with mounting accessories

OUTLET

CORROSIVE GAS

Specifications

Outlets can be used for corrosive gases with purity coefficient up to 6.0 (99.9999% pure gases).

BROEN-LAB UniFlex™ outlets have an integrated media indication according to EN 13792.

Inlet: OD 8mm / ID 6mm

Leak rate: < 10⁻⁷ mbar x l/s [Helium]

Max. wall thickness: 20mm

Weight: 0.6 kg

Materials with media contact

Metals: Stainless Steel (AISI 316L)

Plastics: PVDF

Ordering information

For standard configuration please refer to the item numbers below.

Media should be defined when ordering.

Other options:

- flange
- wall thickness 20-40mm
- additional support in case of a thin panel

For further information, please contact your BROEN-LAB representative.

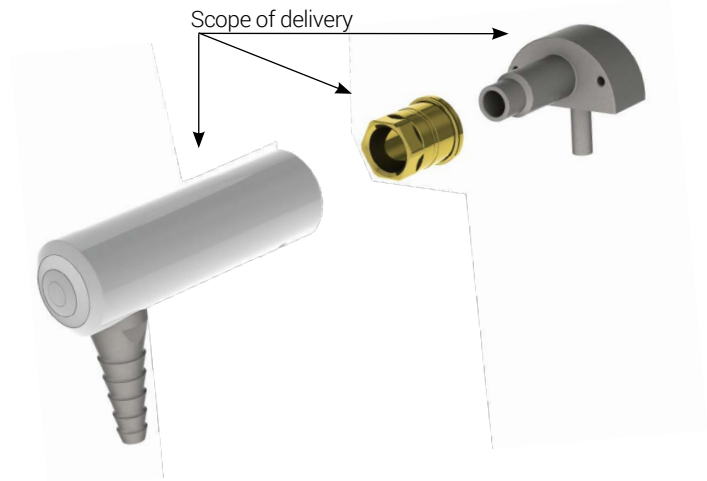



Additional mounting information see page 30-33

To connect flexible pipes to this solutions, remember to offer three Swagelok® from page 29.

See how to install the solution on page 33.

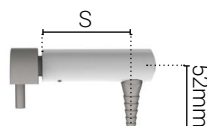
With fixed nozzle



	90° S = 53 mm	90° S = 75 mm	90° S = 90 mm
 Corrosive gases	2511 150 10XX-40	2511 151 10XX-40	2511 152 10XX-40





Media should be defined when ordering.

Delivered with 90° Rear Wall Connection (max wall thickness: 20mm)

ACCESSORIES

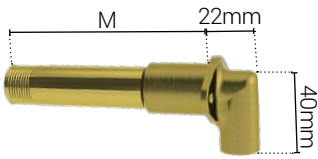
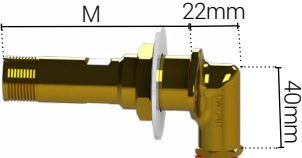
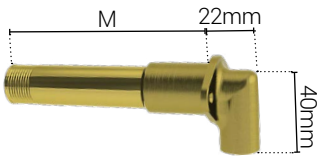
Illustration	Description	Media	BROEN-LAB item no.
	Flange (wall thickness 0-20mm)	All media	1521 057G
	Flange (wall thickness 20-40mm)	All media	1521 178G
	Nut (wall thickness 0-20mm)	All media	1521 036
	Nut (wall thickness 20-40mm)	All media	1521 054
	Straight Rear Wall Connection	Water Burning gas Technical gases 2.0	1521 088
	90° Rear Wall Connection	Water Burning gas Technical gases 2.0	1521 052
	90° Rear Wall Connection	Special water	2511 492
	90° Rear Wall Connection	Technical gases 4.0 + 5.0	1521 0520
	Rear Wall support plate	All media	1521 092
	Test equipment for outlets	Technical gases 2.0	1521 177

ACCESSORIES

Illustration	Description	Media	BROEN-LAB item no.
	<p>Rear wall connection for fume hoods with a double wall construction</p> <p>M = 49 to 61 mm M = 61 to 73 mm M = 73 to 85 mm M = 85 to 97 mm M = 97 to 109 mm</p>	<p>Water Burning gases Technical gases 2.0</p>	<p>2511 494 2511 497 2511 496 2511 495 2511 493</p>
	<p>Rear wall connection for fume hoods with a double wall construction</p> <p>M = 61 to 73 mm M = 73 to 85 mm M = 85 to 97 mm M = 97 to 109 mm</p>	<p>Special water</p>	<p>1530 479 1530 515 1530 534 1530 481</p>
	<p>Rear wall connection for fume hoods with a double wall construction</p> <p>M = 49 to 61 mm M = 61 to 73 mm M = 73 to 85 mm M = 85 to 97 mm</p>	<p>Technical gases 4.0 + 5.0</p>	<p>2511 4940 2511 4970 2511 4960 2511 4950</p>
	<p>Water jet filter pump for spouts (inlet: union nut G3/4, adapter to female G1/2 is included)</p>	<p>Water</p>	<p>1919 9009</p>
	<p>Water jet filter pump for straight outlets (inlet: union nut G3/4, adapter to female G3/8 is included)</p>	<p>Water</p>	<p>1530 4769</p>
	<p>Swagelok® Union OD10-OD8</p>	<p>Water Special water Burning gases Technical gases 2.0</p>	<p>96i0160</p>
	<p>Swagelok® Union OD10-OD8</p>	<p>Technical gases 4.0 + 5.0 + 6.0 Cleanline</p>	<p>96i01600</p>

MOUNTING INSTRUCTIONS FRONT CONTROL VALVES

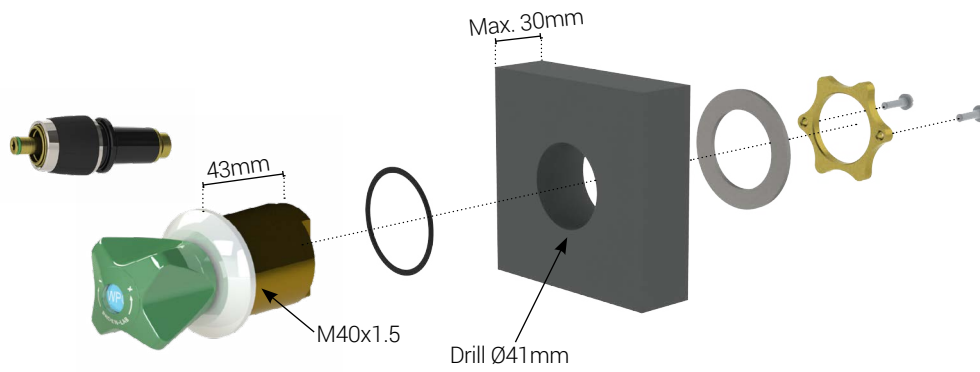

1)

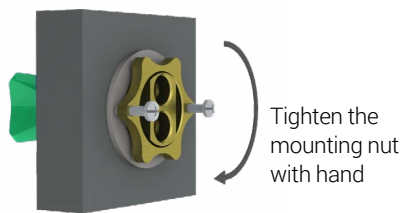

2)

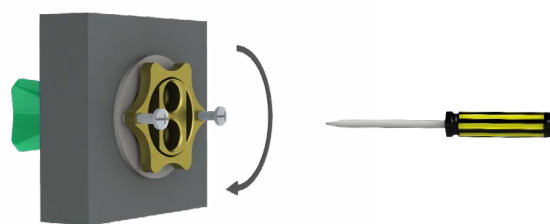

MOUNTING INSTRUCTIONS OUTLETS

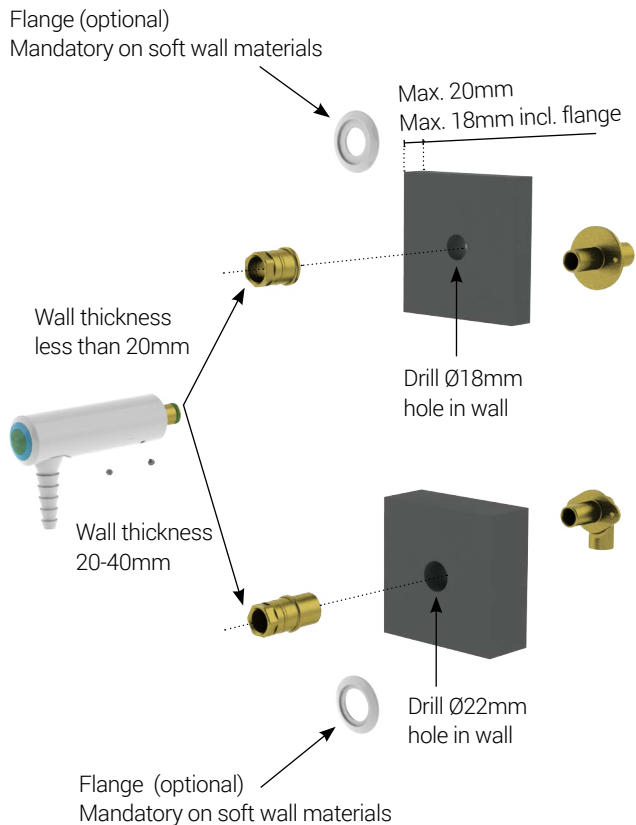

1)

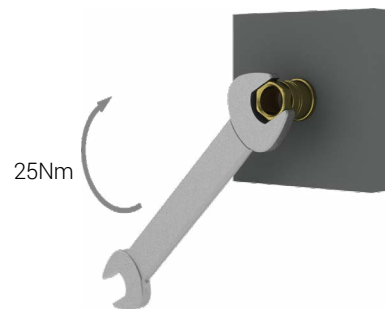

2)



MOUNTING INSTRUCTIONS

MOUNTING OF OUTLETS INTO FUME HOODS WITH A DOUBLE WALL CONSTRUCTION

- 1) Insert the rear wall connection through the back wall

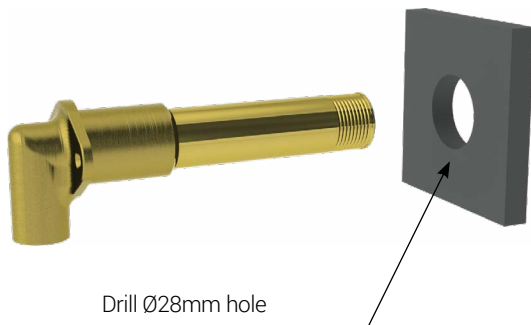

- 2) Fix the outlet to the back wall by tightening the nut

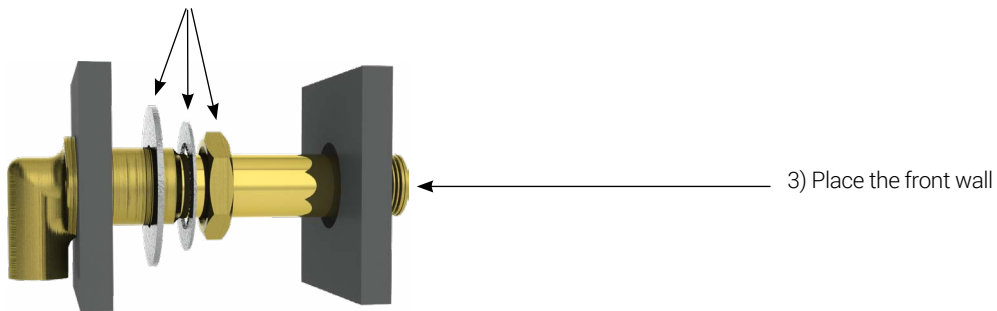

- 4) Position the outlet

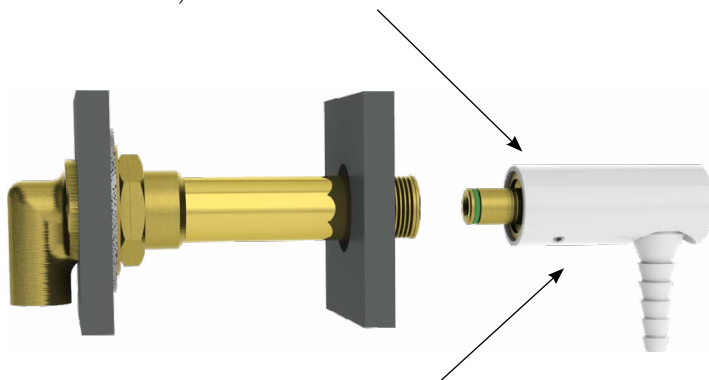

- 5) Tighten Allen screws with Allen key, max 1Nm

PIPE INSTALLATION

WATER / SPECIAL WATER (SS MODEL) / BURNING GASES /
TECHNICAL GASES (2.0, 4.0 AND 5.0)

Valve

Outlet

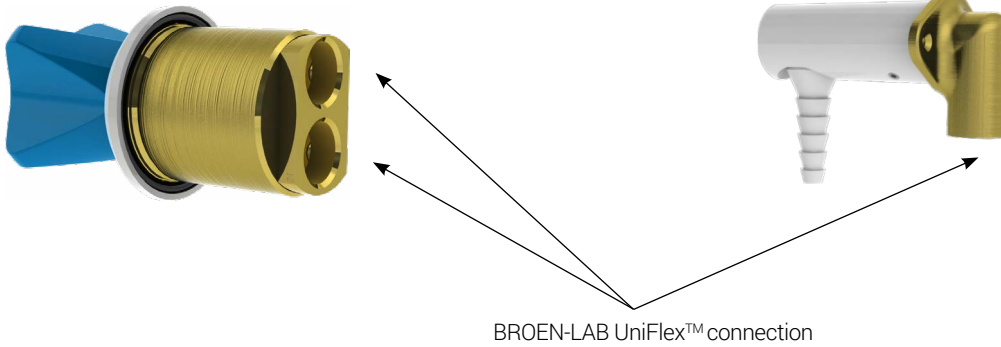

Pipe installation can be done either with flexible hoses or with standard CU, PEX or SS pipes.

BROEN-LAB has a wide range of flexible pipes and hoses available with BROEN-LAB UniFlex™ connections as well as connection fittings to fit pipes of the following sizes:

- OD 8mm
- OD 10mm
- OD 12mm
- OD 15mm
- 3/8"

BROEN-LAB UniFlex™ flexible pipes and hoses

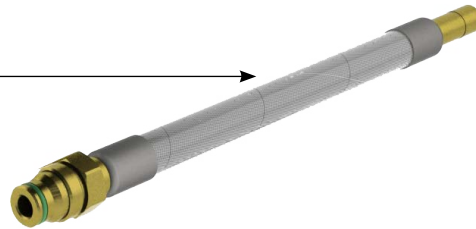

BROEN-LAB UniFlex™ connection fittings and adaptors
for CU, SS, PEX and PA pipes



PIPE INSTALLATION

SPECIAL WATER (PP MODELS ONLY)

Please note that PP valves and outlets for special water are delivered with push-in fittings.

BROEN-LAB recommends the following materials for pipe installation:

Valve

Outlet

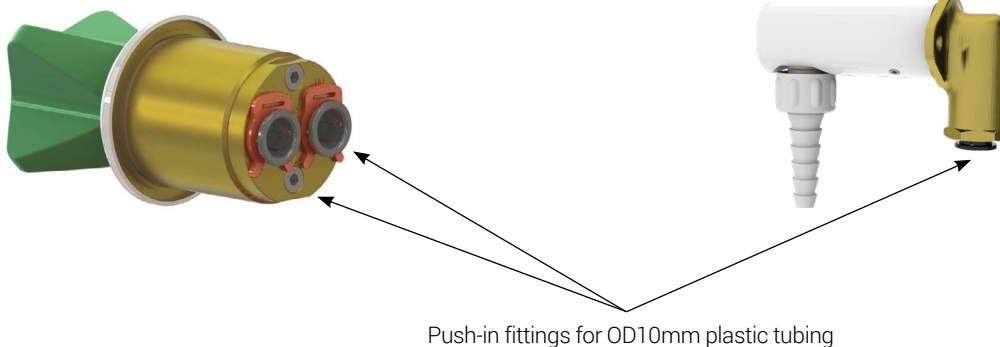

BROEN-LAB recommends the following materials for pipe installation:

- PVDF (can be purchased at BROEN-LAB), LLDPE, PUR

PIPE INSTALLATION

CORROSIVE GASES

Please note that valves and outlets for corrosive gases are delivered in stainless steel and are prepared for orbital welding.
In case of outlet, welding process should take place before mounting into the fume hood.

Valve

Outlet

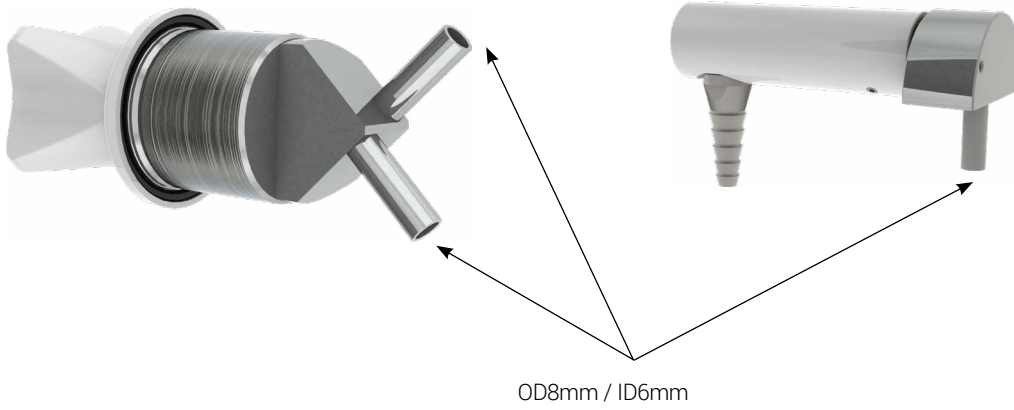

To connect flexible pipes to this solutions, remember to offer three Swagelok® from page 29.
See how to install the solution below.

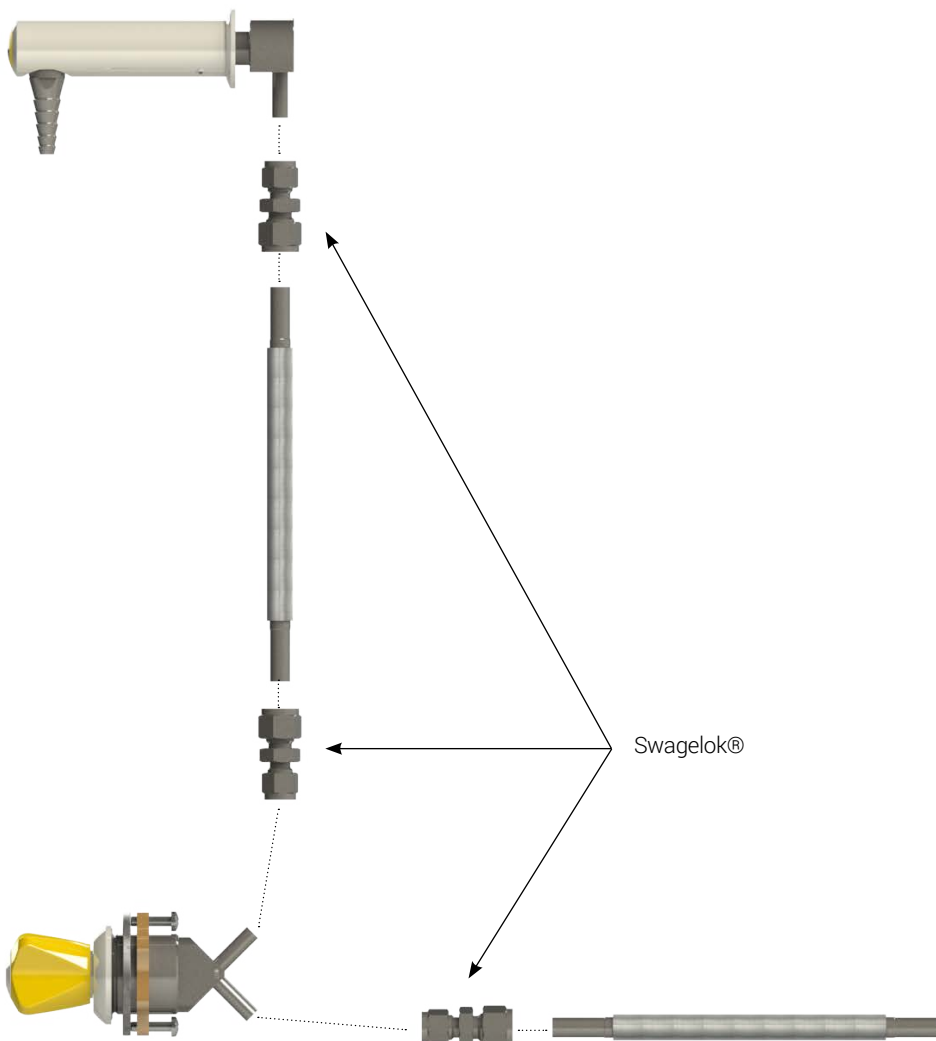

NOTES

HEADQUARTER

BROEN-LAB A/S

Drejervaenget 2
5610 Assens
Denmark

Tel. +45 6376 6376

lab@broen-lab.com
broen-lab.com

INTERNATIONAL OFFICES

BROEN-LAB Ltd.

Tel. +44 121 522 4515

lab@broen-lab.com
broen-lab.com

BROEN-LAB Singapore Pte. Ltd.

25 International Business Park
#04-60A German Centre
Singapore 609916

Tel. +65 6298 0662

lab@broen-lab.com
broen-lab.com

BROEN-LAB GmbH

Tel. +45 6376 6376

lab@broen-lab.com
broen-lab.com

BROEN-LAB Sverige AB

Tel. +45 6376 6376

lab@broen-lab.com
broen-lab.com

BROEN-LAB Inc.

15 Constitution Drive
Suite 122
NH 03110
Bedford
USA

Tel. +1 603 310 5089

lab@broen-lab.com
broen-lab.com

BROEN-LAB develops, manufactures and sells Laboratory Fittings, Emergency Shower Systems and Eye Wash Systems into a broad spectrum of laboratories and industrial locations; sectors include Pharmaceutical, Food&Beverage and Academia. Our expertise and product quality ensure optimal solutions compliant to all relevant international norms setting new standards in risk mitigation in modern research and development facilities.

BROEN-LAB offers solutions that ensure the functionality, compliance, hygiene, durability and safety are of the highest priority. For more than 50 years our products have been integrated into a wide variety of workplaces, laboratories, hospitals and industrial locations, with features that are assessed and designed to be flexible, durable and compliant offering a broad range of options tailored to each location. This inherent design integrity provides confidence in the solution adopted wherever in the world these are applied.

BROEN-LAB is a collaboration partner in the design and layout of your next laboratory and it's integrated safety.



BROEN-LAB A/S ISO 9001 certification

In September 1991 BROEN-LAB A/S was certified according to ISO 9001 as one of the first Danish companies. The certification was carried out by Bureau Veritas, Denmark, for our Danish site in Assens.

The quality management system of BROEN-LAB A/S now complies with detailed specifications laid down by the internationally acknowledged EN ISO 9001:2015. This certification will further contribute to reputation for quality and reliability of BROEN-LAB A/S.

BROEN-LAB A/S ISO 14001:2015 certification

In December 2022 we got certified according to ISO 14001 in Environmental certification. The new certification was carried out by Bureau Veritas, Denmark, for Danish site in Assens. The Environment ISO14001 management system of BROEN-LAB A/S is included in internationally acknowledged EN ISO 9001:2015. Both certifications furthermore contribute to reputation for quality and reliability of BROEN-LAB A/S.